

MERIDIAN SOLID SURFACE ONE-PIECE SHOWER BASE

Model # MSB4836S

48" x 36"

- Integral shower floor and threshold for alcove installation
- Choose from a variety of solid colors and granite-patterned colors
- Easy to clean surface, does not promote mold or mildew
- Textured flooring helps prevent slipping
- Tapered floor helps water flow to drain
- Rigid water barrier integrated into base
- Uses standard 2" NPS strainer assembly
- Certified by Home Innovation Research Labs to the harmonized CSA B45.5/IAPMO Z124
- Approved by the Massachusetts Board of Examiners of Plumbers and Gasfitters



Section Thru Waterdam

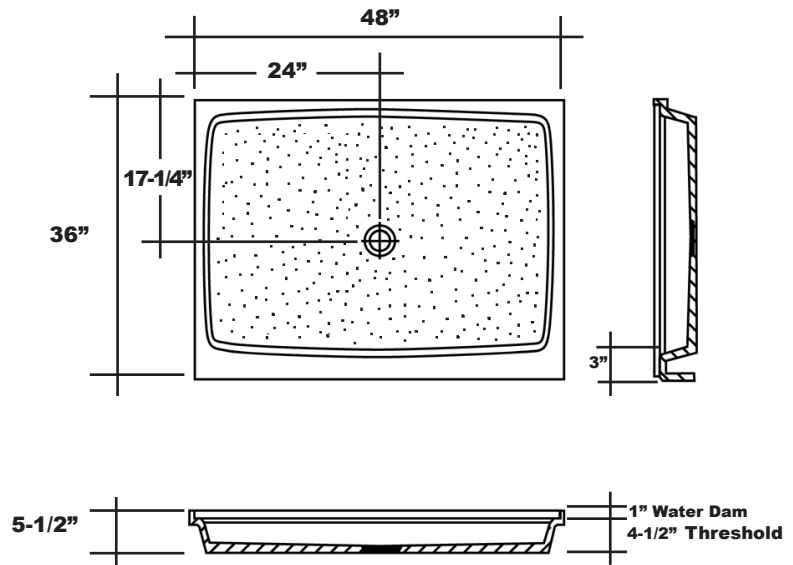
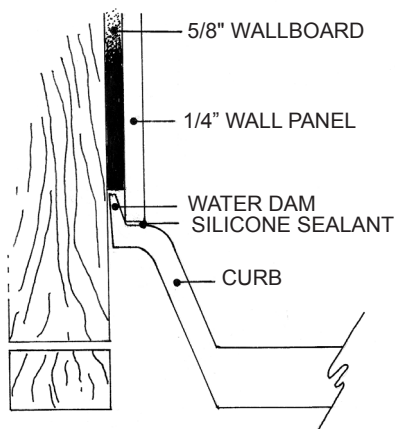

Massillon, OH 44647
330-837-2216

www.TowerShowers.com

www.TowerSinks.com

TOWER
INDUSTRIES
www.TowerSurfaces.com