

MERIDIAN UNDERMOUNT KITCHEN SINKS

160

Model # MKS160
Sink Weight 68 Lbs.



- Meridian sinks are suitable for undermount applications in a variety of residential and light commercial environments
- Each sink is made from a homogeneous blend of polyester and acrylic polymers engineered to bring together performance and style in every application
- Non-porous surface resists mold, mildew, and stains
- Fits into a 36" or larger sink base cabinet
- Approved by the Massachusetts Board of Examiners of Plumbers and Gasfitters
- Certified by the NAHB research center to the ANSI Z124 standard

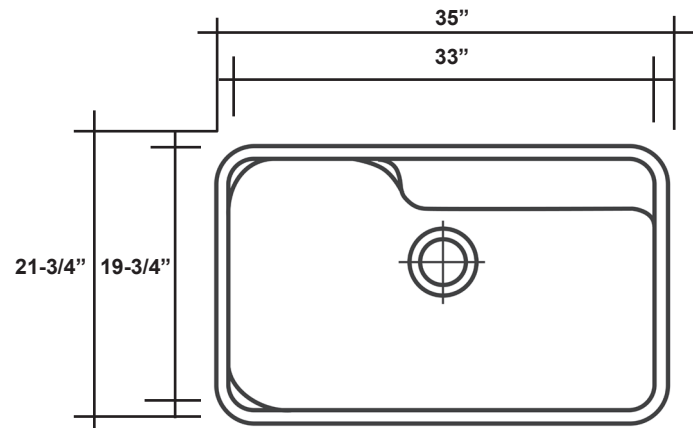

Massillon, OH 44648
330-837-2216

www.TowerShowers.com

www.TowerSinks.com

**TOWER**
INDUSTRIES
www.TowerSurfaces.com